



ECCO[®] CERO

acoustic comfort



Collections by ECOcero®

EN. ECOcero® is not just turning plastic bottles into decorative panels. Thanks to our R&D&I team's technical innovation, we can create all you can imagine: curved, bevelled, painted panels... A whole new universe of possibilities for unique comfort and design.

ES. ECOcero® no solo transforma botellas de plástico en paneles acústicos decorativos. Las innovaciones tecnológicas de nuestro equipo de I+D+I ha hecho posible obtener cualquier resultado que podamos imaginar: paneles curvos, biselados, troquelados, pintados, etc. Todo un universo de posibilidades para que el confort y el diseño sea inigualable.

FR. ECOcero® ne transforme pas seulement les bouteilles en plastique en panneaux acoustiques décoratifs. Les innovations technologiques de notre équipe R&D&I nous ont permis d'obtenir tous les résultats que nous pouvons imaginer. À partir de panneaux arrondis, biseautés, découpés, peints, etc. Tout un univers de possibilités pour un confort et un design inégalés.

PT. ECOcero® não só transforma as garrafas de plástico em painéis acústicos decorativos. As inovações tecnológicas da nossa equipa de I&D&I tornaram-nos possível obter qualquer resultado que possamos imaginar: painéis curvos, biselados, cortados sob pressão, pintados, etc. Todo um universo de possibilidades para um conforto e design inigualáveis.

DE. ECOcero® verwandelt nicht nur Kunststoffflaschen in dekorative Akustikplatten, sondern die technologischen Innovationen unseres F&E&I Teams haben es auch ermöglicht, jedes erdenkliche Ergebnis zu erzielen: Gebogenen, abgeschrägte, gestanzte, lackierten Platten, usw. Ein ganzes Universum an Möglichkeiten für unübertroffenen Komfort und Design.

Designers

Rafa Ortega



An inventor of solutions, a designer of ideas. Passionate about innovation and tireless visionary. Creativity, love and work have come patents that contribute to more comfortable and sustainable world.

Rafa Ortega is one of the exponents of Valencian design that from Gutierrez y Ortega, the studio he runs with Cristina Gutiérrez, has been bringing excitement and creativity to the development of domestic products and products for offices, communities, and catering for nearly 30 years.

Differentiating solutions that guides him exhaustively during all the processes that are part of the new project, from identifying a need to the launching the final product and its effectiveness.

Welcome design

A multidisciplinary team with extensive experience and passion for design, which develops each project by and for the client, from its conceptualization and realization, to its execution and feedback.

More than 20 years of combined experience in interior design, graphic design, own productions and special pieces.

Exclusive designs, an adventure to find most special pieces. An infinite range of colors and a careful selection of repetition and mural designs that adapt to any space



Cocreations

Greenarea



Specialised in creative, innovative and versatile plant decoration with mosses and preserved plants, 100% natural without irrigation or maintenance.

Greenarea has been connecting nature and design since 2011 through vertical gardens and biophilic solutions that go beyond aesthetics, helping to fill with sensations and improve wellbeing in interior spaces anywhere in the world.

In addition to made-to-measure compositions, Greenarea Collection explores new ways of incorporating nature in interiors together with signature design.

Among them is OTOgreen by Rafa Ortega: an innovative line of planters and sound-absorbing, vegetable and sustainable panels made with the ECO Line of ECOcero.

ECOcero

The ECOcero design team, led by Miguel Hernández, has become a benchmark in the field of Spanish industrial design. Its commitment to R&D and Innovation has developed new technologies that have allowed to implement countless possibilities for the creation and customization of acoustic panels.

Research into fashion and market trends led to a change in the design paradigm, but also in acoustics. In this way, they have managed to facilitate the previously complex assembly processes, improving the acoustic qualities while at the same time generating new design trends.

Thanks to their strong commitment to sustainability, they have become a leading reference for large international companies that have chosen them to adapt their image in their transition towards acoustic comfort.









CRANBURY
Deli bar

DE CERVEZAS AFINADAS

DE CERVEZAS AFINADAS

CODE Technical data

Continuous sound-absorbing technical ceiling, ECOcero's CODE model, composed of acoustic panels of recycled polyester fiber 1200 x 600 x 9 mm with linear perforations, in two models and color to choose, including p/p of decorative band and hanging bridge system to hidden profiling. Optional extra ribs, signage and boxes to house lighting. CE marked, Euroclass B-s2, d0 reaction to fire, compliance with the low VOC emission specifications with GOLD certification in LEED and BREEAM.



CODE Bands



Light Box



Signage



Discover all available signage

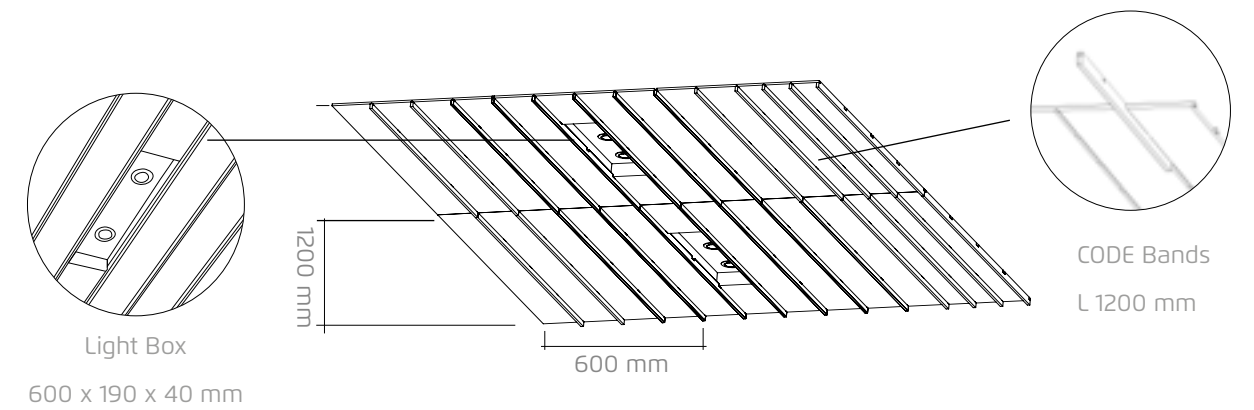

CODE Bands
L 1200 mm

CODE plus

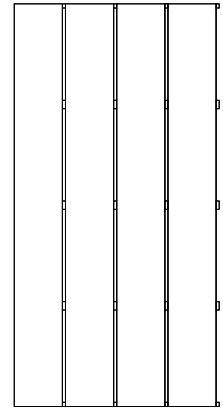

CODE mini

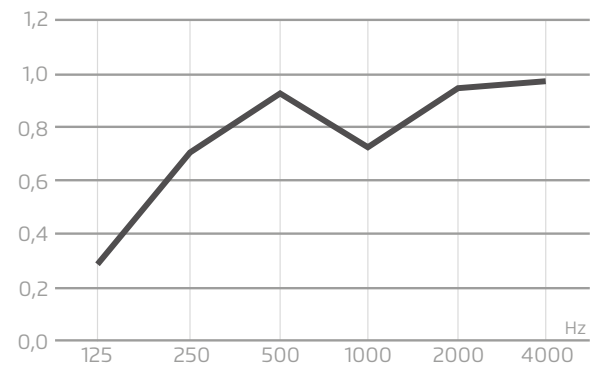
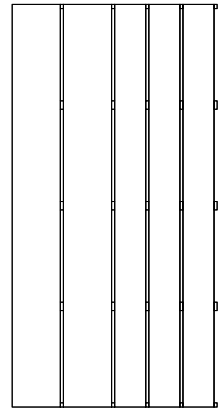

AVAILABLE SIZE
1200 mm x 600 mm

AVAILABLE THICKNESS
— 9 mm (NRC: 0,78)

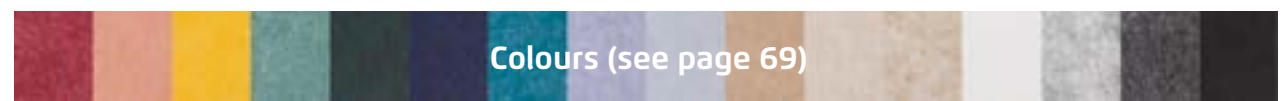

ECO line colours





ECO-104*



ECO-147



ECO-101



ECO-107



ECO-112



ECO-125



ECO-127



ECO-138

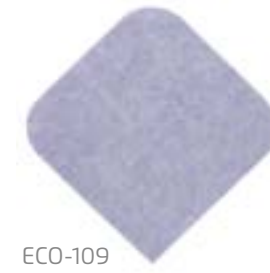

ECO-109



ECO-139



ECO-140

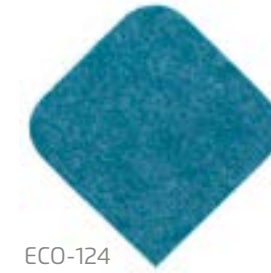

ECO-124



ECO-116



ECO-131



ECO-120



ECO-102

* It can be painted in any colour.

¿Cuál es su uso?

Los paneles acústicos ECOcero® reducen el tiempo de reverberación, lo que comúnmente se conoce como eco.

Mejorando el confort acústico y reduciendo los niveles de ruido en interiores.

¿Qué es la reverberación?

Es el tiempo que un sonido permanece audible en el interior de una sala.

Normalmente, cuanto menor sea el tiempo de reverberación, mayor será el confort acústico.

¿Cómo se determina la absorción acústica de los paneles?

ECOcero® realiza los ensayos de los paneles acústicos en laboratorios independientes acreditados por ENAC con cámara de aire de 200 mm para la gama ECO y sin cámara para la gama FOAM.

¿Qué garantía tengo de que funcione?

No solo usamos los mejores materiales, sino que te indicaremos de forma gratuita el tratamiento acústico adecuado para tu proyecto.

De ahí que las mejores marcas confíen en nosotros.

Recomendaciones de instalación

Los paneles ECOcero puede instalarse pegados o suspendidos.

En ambos casos deberán ir instalados con el adhesivo y sistemas de anclaje suministrados por ECOcero®, siguiendo las indicaciones del fabricante.

¿Cuál es el tiempo de reverberación (TR) ideal?

Cada actividad tiene un TR recomendado. Accede a nuestra app ECOtr de forma gratuita para conocer el tratamiento acústico ideal de tu local.

¿Cómo puedo conocer el tiempo de reverberación de mi local?

Aparte de un sonómetro profesional, la herramienta de cálculo gratuita ECOtr también permite estimar el tiempo de reverberación indicando las características de tu local.

¿Dónde se instalan los paneles acústicos?

La Gama ECO puede instalarse en paredes, techo, o como elemento divisorio de mesas.

¿Cómo se instala el material?

1. Pegado con el adhesivo especial ECOcero®. Es la más sencilla y económica.
2. Suspendido. Permite jugar con las alturas y volúmenes, a través de los anclajes distribuidos por ECOcero®.

Limpieza

Los paneles acústicos ECOcero® se limpian mediante aire a presión en seco. Para la eliminación de manchas persistentes se recomienda aplicar de agua oxigenada durante varias horas.



ECO[®] caro