

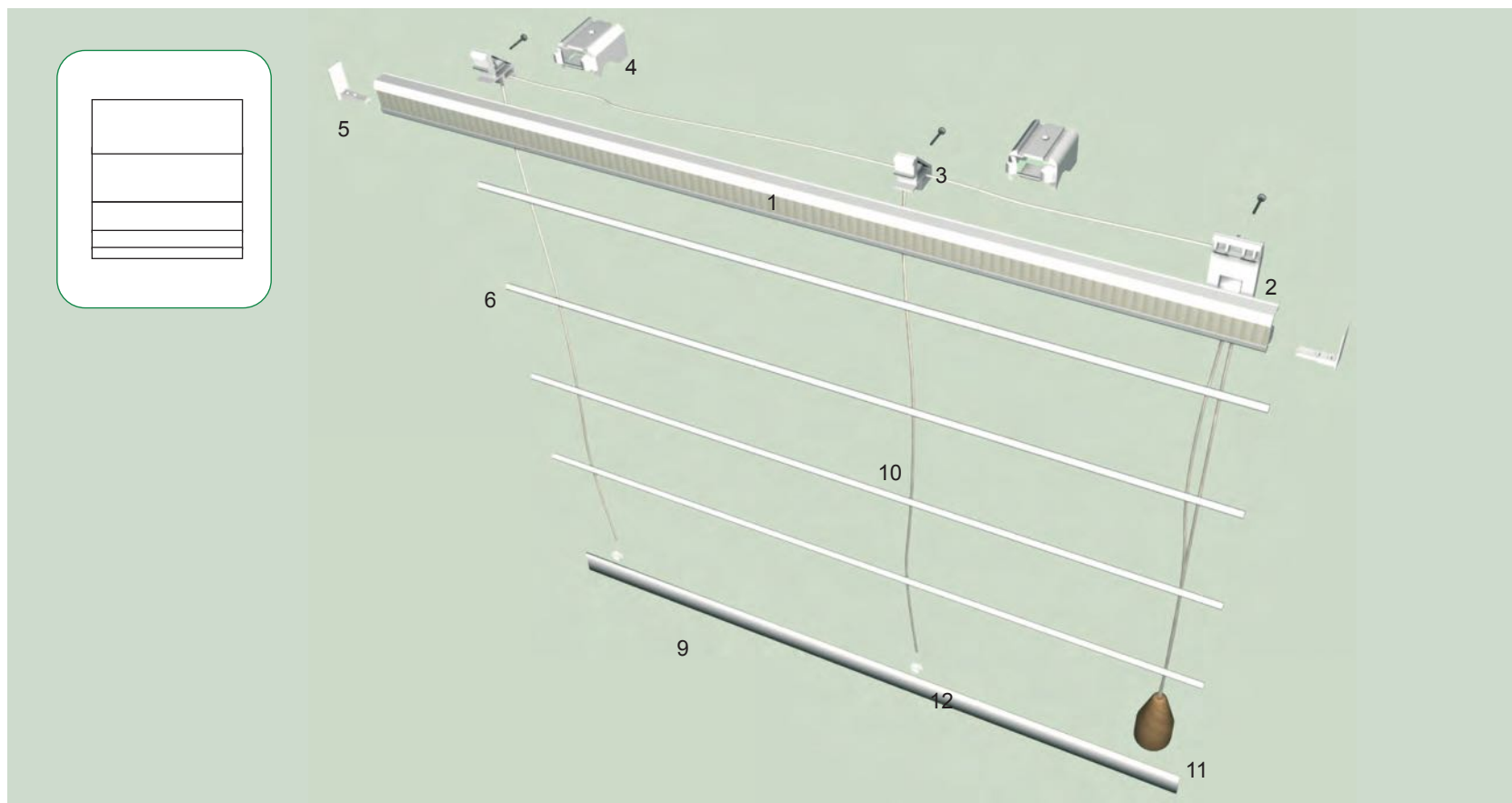

Estores



componentes

artículo	Und.	medida
1 - Perfil 2005 velcado	1	= stor
2 - Freno rodillo metal	1	---
3 - Guia caída cuerda	2, 3 o 4	---
4 - Soporte universal 3cm.	2, 3 o 4	---
5 - Terminal perfil	2	---
6 - Varilla fibra 4mm.	8	= stor
7 - Trivel 20mm. liso	---	= stor
8 - Cinta stor vh blanco	---	= varilla
9 - Pletina aluminio 25x3mm.	1	= stor
10 - Cordón stor vh 1'5mm.	---	= stor
11 - Pomo madera	1	---

CÓDIGO	medida	caídas	Und./Caja	€/Und.
5015106	60	2	30	19,116
5015107	70	2	30	19,524
5015108	80	2	30	19,914
5015109	90	2	30	20,708
5015110	100	2	30	21,506
5015111	110	2	30	23,098
5015112	120	2	30	24,694
5015113	130	2	30	26,284
5015114	140	2	30	28,197
5015115	150	3	30	29,793
5015116	160	3	30	31,382
5015117	170	3	30	32,976
5015118	180	4	30	34,570
5015119	190	4	30	36,162
5015120	200	4	30	37,756
5015121	210	4	30	39,346
5015122	220	4	30	40,944
5015123	230	4	30	42,535
5015124	240	4	30	44,129
5015125	250	4	30	45,721

Altura máxima de la caída de 2'50 mts / Las medidas especiales o demás variaciones sufrirán un incremento del 10% por manipulación.

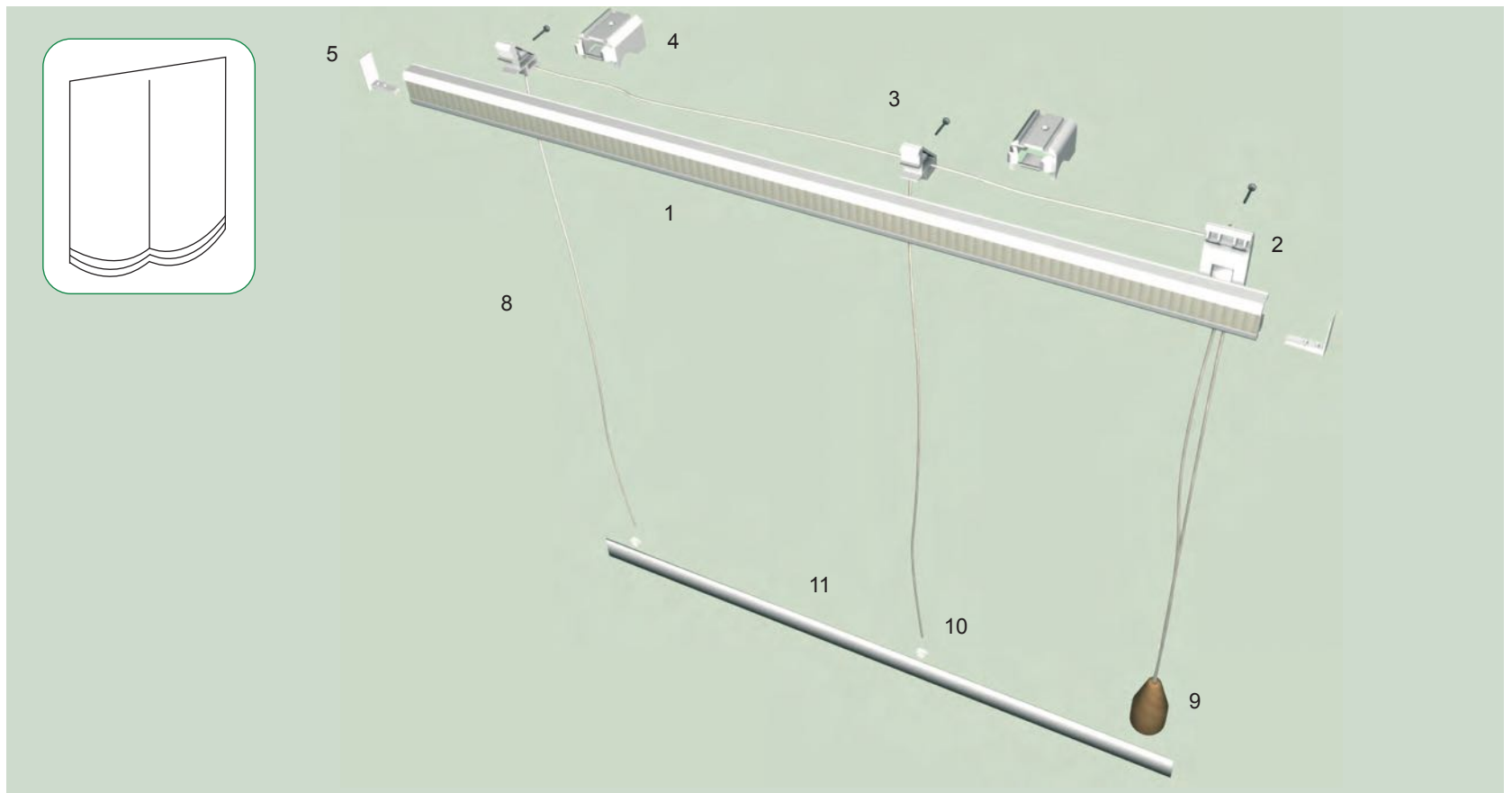

componentes

artículo	Und.	medida
1 - Perfil 2005 velcro	1	= stor
2 - Freno rodillo metal	1	---
3 - Guia caída cuerda	2, 3 o 4	---
4 - Soporte universal 3cm.	2, 3 o 4	---
5.- Terminal perfil	2	---
6 - Trivel 20mm. liso	---	= stor
7 - Romana presillas transp.	1	= caídas
8 - Cordón stor vh 1'5mm.	---	= stor
9 - Pomo madera	1	---
10 - Garfio vh	2, 3 o 4	---
11 - Pletina aluminio 25x3mm	1	= stor

CÓDIGO	medida	caídas	Und./Caja	€/Und.
5015206	60	2	30	18,423
5015207	70	2	30	18,885
5015208	80	2	30	19,652
5015209	90	2	30	20,563
5015210	100	2	30	21,073
5015211	110	3	30	22,346
5015212	120	3	30	24,230
5015213	130	3	30	26,212
5015214	140	3	30	27,516
5015215	150	3	30	28,602
5015216	160	4	30	31,095
5015217	170	4	30	32,224
5015218	180	4	30	33,062
5015219	190	4	30	33,673
5015220	200	4	30	34,686
5015221	210	5	30	37,609
5015222	220	5	30	38,682
5015223	230	5	30	39,829
5015224	240	5	30	41,015
5015225	250	5	30	41,954

Altura máxima de la caída de 2'50 mts / Las medidas especiales o demás variaciones sufrirán un incremento del 10% por manipulación.

perfil 2005 velcrado

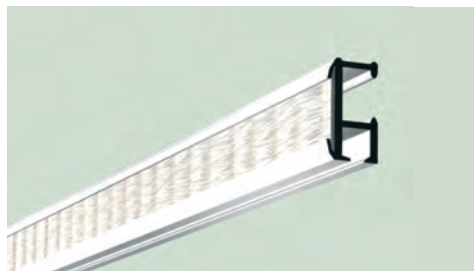

color	CÓDIGO	Mts./Caja	€/Mts.
blanco	5001551	288	5,216

freno rodillo metal (nylon)



CÓDIGO	Und./Caja	€/Und.
5002504	100	1,840

guia caída cuerda con tornillo (nylon)



CÓDIGO	Und./Caja	€/Und.
5002533	300	0,349

soporte universal 3cm. (nylon)



CÓDIGO	Und./Caja	€/Und.
5002502	100	0,437

soporte universal 4cm. (nylon)

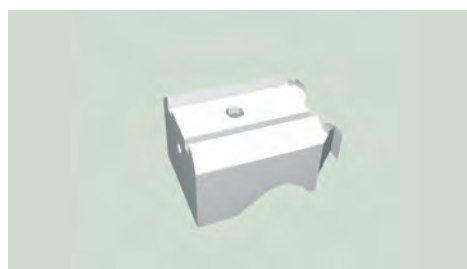

CÓDIGO	Und./Caja	€/Und.
5002536	100	0,477

soporte universal 7cm. (nylon)



CÓDIGO	Und./Caja	€/Und.
5002537	20	1,649

soporte palanca corto



medida	CÓDIGO	Und./Caja	€/Und.
3cm.	5002630	100	0,565
4cm.	5002582	100	0,557

soporte palanca largo



medida	CÓDIGO	Und./Caja	€/Und.
5cm.	5002632	50	1,103
6cm.	5002601	50	1,649

soporte techo (nylon)



CÓDIGO	Und./Caja	€/Und.
5002503	100	0,550

clip bloqueo (para galón o cordón nylon)

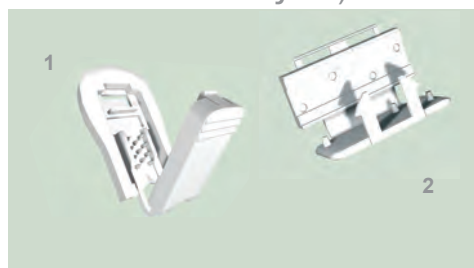

mod	CÓDIGO	Und./Caja	€/Und.
1	5002600	50	0,418
2	5002633	50	0,418

terminal perfil (nylon)



CÓDIGO	Und./Caja	€/Und.
5002512	100	0,258

pomo madera



color	CÓDIGO	Und./Caja	€/Und.
mate	5002558	50	0,796
encerado	5002727	50	1,269

pomo campanilla plástico



CÓDIGO	Und./Caja	€/Und.
5002520	100	0,181

cordón estor

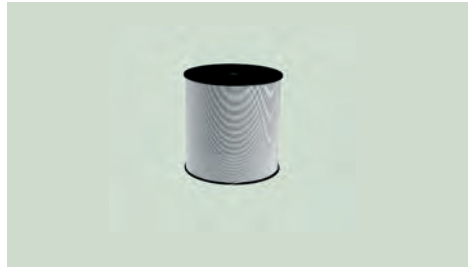

grosor	CÓDIGO	Mts/Bob	€/Mts.
1,1	5008741	500	0,095
1,5	5008740	500	0,090
2	9001925	500	0,123

empalme de cuerdas latón



CÓDIGO	Und./Caja	€/Und.
5002540	100	3,040

empalme cuerdas plástico



CÓDIGO	Und./Caja	€/Und.
5002518	100	0,464

1 anilla stor modelo "D"
2 anilla veneciana



Mod	CÓDIGO	Und./Caja	€/Und.
1	5002539	100	0,072
2	5002605	100	0,151

contrapeso triangular
veneciana



CÓDIGO	Und./Caja	€/Und.
5002521	200	1,900

garfio vh



color	CÓDIGO	Und./Caja	€/Und.
blanco	5006715	1.000	0,035
transp.	5006719	1.000	0,044

pieza unión metal 8cm.



CÓDIGO	Und./Caja	€/Und.
5002516	50	2,522

varilla fibra de vidrio (4mm)



CÓDIGO	Mts./Caja	€/Mts.
5007745	600	0,405

pletina aluminio blanco



medida	CÓDIGO	Mts./Caja	€/Mts.
25x3	5007534	180	4,200
40x3	5007536	180	7,352
30x4	5007533	180	7,423

pletina transparente



medida	CÓDIGO	Mts./Caja	€/Mts.
40x5	5007545	150	7,929

protector pletina



medida	CÓDIGO	Und./Caja	€/Und.
25x3	5007541	200	0,183
40x3	5007542	200	0,246
30x4	5007543	200	0,220

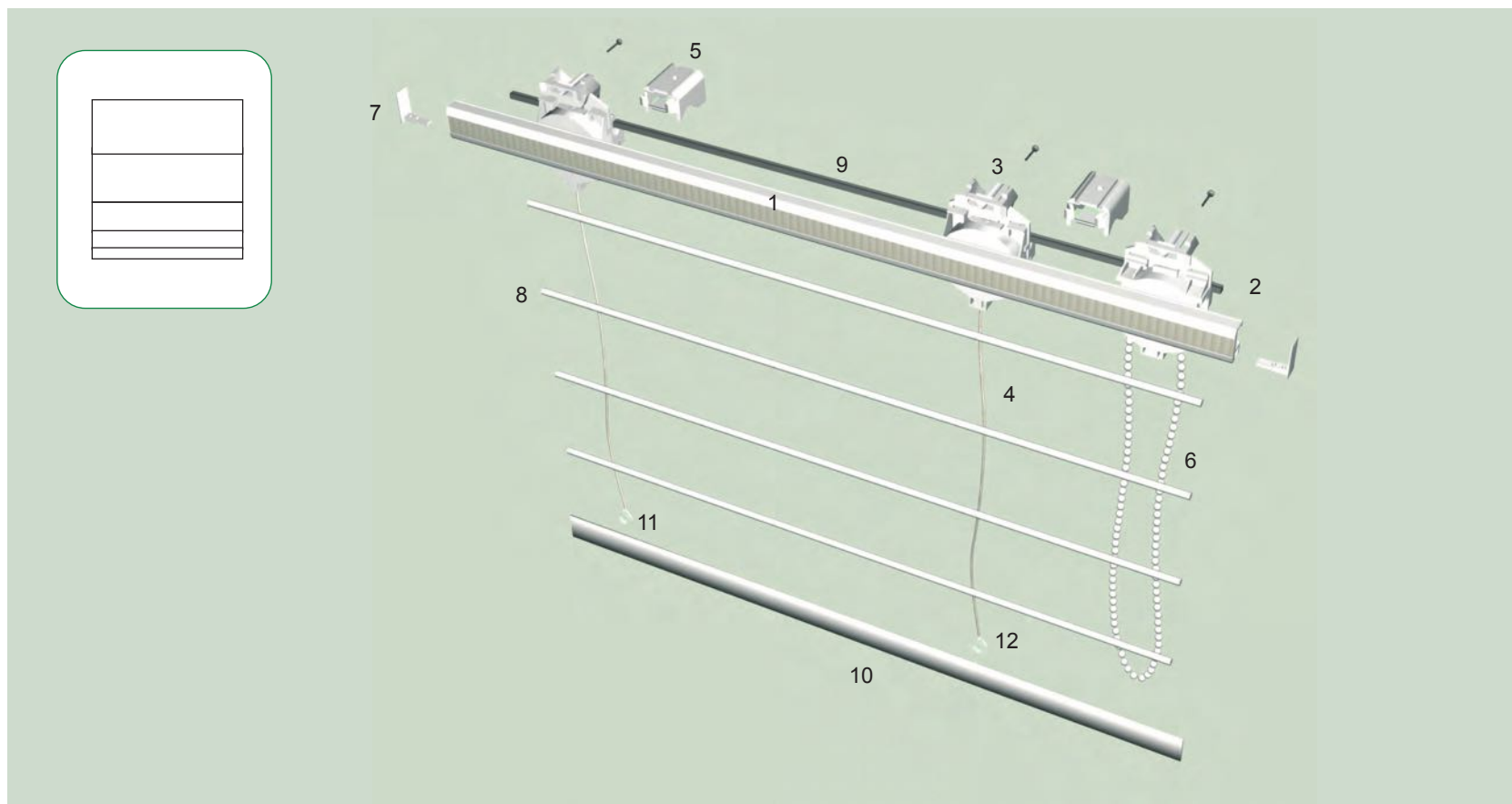

componentes

artículo	Und.	medida
1 - Perfil 2005 velcro blanco	1	= stor
2 - Frena cadena 2K	1	---
3 - Caja galón	2, 3 o 4	---
4 - Cinta galón blanco	---	2'60 x caída
5 - Soporte universal de 4	2, 3 o 4	---
6 - Cadena accionamiento	---	2,5mts.
7 - Terminal perfil	2	---
8 - Varilla fibra 4mm.	8	= stor
9 - Barra movil	1	= stor
10 - Pletina aluminio 25x3mm.	1	= stor
11 - Anilla final (modelo pera)	2, 3 o 4	---
12 - Cinta stor vh BLANCO	---	= varilla
13 - Trivel 20mm liso	---	= stor

CÓDIGO	medida	caídas	Und./Caja	€/Und.
5015506	60	2	15	35,658
5015507	70	2	15	37,149
5015508	80	2	30	38,785
5015509	90	2	30	40,276
5015510	100	2	30	41,767
5015511	110	2	30	43,418
5015512	120	2	30	45,053
5015513	130	2	30	46,549
5015514	140	2	30	48,489
5015515	150	3	30	54,598
5015516	160	3	30	56,248
5015517	170	3	30	57,742
5015518	180	3	30	59,233
5015519	190	3	30	60,871
5015520	200	3	30	62,362
5015521	210	4	30	68,617
5015522	220	4	30	70,268
5015523	230	4	30	71,906
5015524	240	4	30	73,542
5015525	250	4	30	75,195

Altura máxima de la caída de 2'50 mts / Las medidas especiales o demás variaciones sufrirán un incremento del 10% por manipulación.

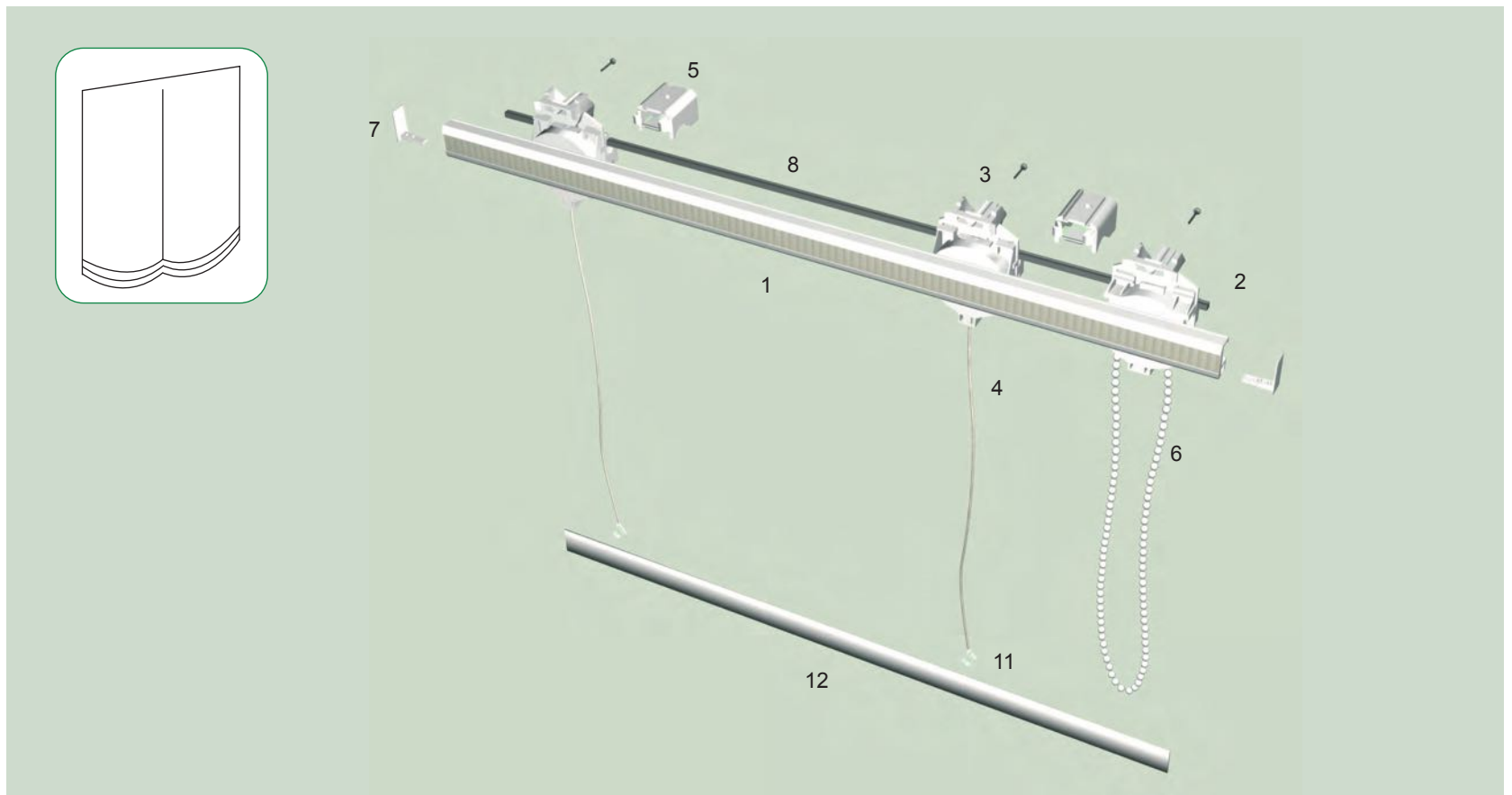

componentes

artículo	Und.	medida
1 - Perfil 2005 velcrado	1	= stor
2 - Freno cadena 2K	1	---
3 - Caja galón	2, 3 o 4	---
4 - Cinta galón transparente.	---	2'60 x caída
5 - Soporte universal de 4	2, 3 o 4	---
6 - Cadena accionamiento	---	2,5mts.
7 - Terminal perfil	2	---
8 - Barra móvil	1	---
9 - Romana presillas transp	1	= caidas
10 - Trivel 20mm liso	---	= stor
11 - Anilla final (modelo pera)	---	= 2,3 o 4r
12 - Pletina 25x3	1	= stor

CÓDIGO	medida	caídas	Und./Caja	€/Und.
5015406	60	2	15	35,482
5015407	70	2	15	36,931
5015408	80	2	15	38,522
5015409	90	2	15	44,159
5015410	100	2	15	45,011
5015411	110	3	15	46,026
5015412	120	3	15	53,395
5015413	130	3	15	54,251
5015414	140	3	15	55,528
5015415	150	3	15	56,263
5015416	160	4	15	63,607
5015417	170	4	15	64,432
5015418	180	4	15	65,287
5015419	190	4	15	66,257
5015420	200	4	15	67,112
5015421	210	5	15	74,323
5015422	220	5	15	75,310
5015423	230	5	15	76,308
5015424	240	5	15	77,280
5015425	250	5	15	78,294

Altura máxima de la caída de 2'50 mts / Las medidas especiales o demás variaciones sufrirán un incremento del 10% por manipulación.

perfil 2005 velcrado (blanco)

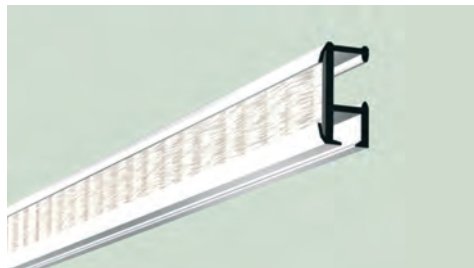

CÓDIGO	Mts./Caja	€/Mts.
5001551	288	5,216

freno cadena



fuerza	CÓDIGO	Und./Caja	€/Und.
2 kg	5002554	100	4,259
4'5 kg	5002555	100	4,259

freno cadena-montada.
sin fin 2 Kg.



medida	CODIGO	Und./Caja	€/Und.
1'00	5002597	100	9,442
1'25	5002564	100	10,078
1'50	5002588	100	10,716
1'75	5002589	100	11,353
2'00	5002590	100	11,989
2'25	5002596	100	12,631
2'50	5002591	100	13,266

freno cadena-montada.
sin fin 4'5 Kg.



medida	CODIGO	Und./Caja	€/Und.
1'00	5002599	100	9,442
1'25	5002565	100	10,078
1'50	5002592	100	10,716
1'75	5002593	100	11,353
2'00	5002594	100	11,989
2'25	5002598	100	12,631
2'50	5002595	100	13,266

caja galón



CÓDIGO	Und./Caja	€/Und.
5002556	100	3,476

caja galón montada (caída
2'60 mts.)



color	CÓDIGO	Und./Caja	€/Und.
blanco	5002561	100	4,941
transp.	5002542	100	5,248

barra móvil cuadrada 5x5

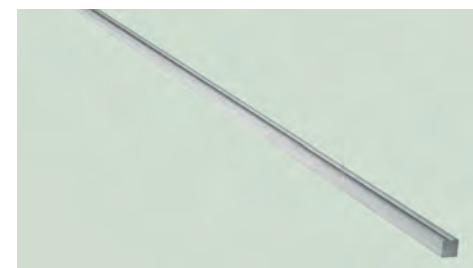

CÓDIGO	Mts./Caja	€/Mts.
5002553	360	2,173

soporte universal 3cm.
(nylon)

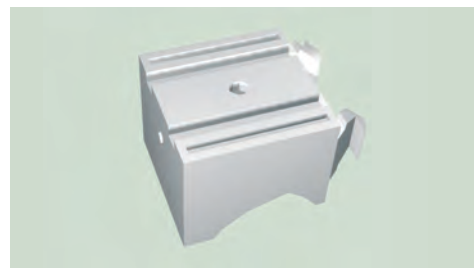

CÓDIGO	Und./Caja	€/Und.
5002502	100	0,437

soporte universal 4cm.
(nylon)



CÓDIGO	Und./Caja	€/Und.
5002536	100	0,477

soporte universal 7cm.
(nylon)



CÓDIGO	Und./Caja	€/Und.
5002537	20	1,649

soporte palanca corto



medida	CÓDIGO	Und./Caja	€/Und.
3cm.	5002630	100	0,565
4cm.	5002582	100	0,557

soporte palanca largo



medida	CÓDIGO	Und./Caja	€/Und.
5cm.	5002632	50	1,103
6cm.	5002601	50	1,649

soporte techo (nylon)



CÓDIGO	Und./Caja	€/Und.
5002503	100	0,550

soporte techo con lengüeta



CÓDIGO	Und./Caja	€/Und.
5002675	100	0,458

terminal perfil (nylon)



CÓDIGO	Und./Caja	€/Und.
5002512	100	0,258

pomo



CÓDIGO	Und./Caja	€/Und.
5033256	50	2,059

cadena accionamiento 4'5x6



color	CÓDIGO	Mts./Bob.	€/Mts.
blanco	5002525	250	1,276
transp.	T5002525	250	1,283

empalme bloqueo cadena pequeño



color	CÓDIGO	Und./Caja	€/Und.
blanco	5002557	1000	0,288
transp.	T5002557	1000	0,288

cadena continúa



color	CÓDIGO	Und./Caja	€/Und.
1'00	5002522	50	4,748
1'25	5002567	50	5,389
1'50	5002534	50	6,025
1'75	5002535	50	6,663
2'00	5002560	50	7,298
2'50	5002569	50	8,572

cadena metálica 4'5x6



CÓDIGO	Mts./Bob.	€/Mts.
M5002525	125	1,948

empalme cadena metálica

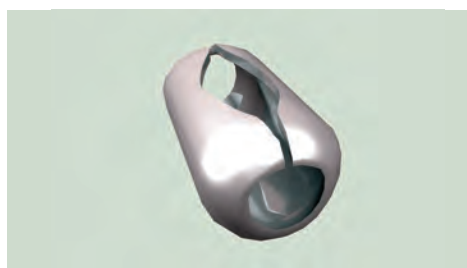

CÓDIGO	Und./Caja	€/Und.
M5002557	100	0,533

cadena continúa metálica

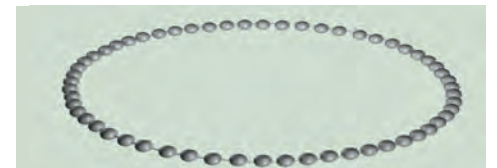

color	CÓDIGO	Und./Caja	€/Und.
1'00	M5002560	50	5,109
1'25	M5002561	50	6,084
1'50	M5002562	50	7,058
1'75	M5002563	50	8,033
2'00	M5002564	50	9,007
2'50	M5002565	50	10,956

cinta galón 5mm.



color	CÓDIGO	Mts./Bob.	€/Mts.
blanco	5002766	200	0,242
beige	5002767	200	0,252
transp.	5002769	200	0,330

anilla final modelo pera (transp.)



CÓDIGO	Und./Caja	€/Und.
5002531	500	0,088

triángulo plástico



CÓDIGO	Und./Caja	€/Und.
5002517	100	0,233

anilla veneciana transparente



CÓDIGO	Und./Caja	€/Und.
5002605	100	0,151

clip bloqueo (para galón o cordón nylon)

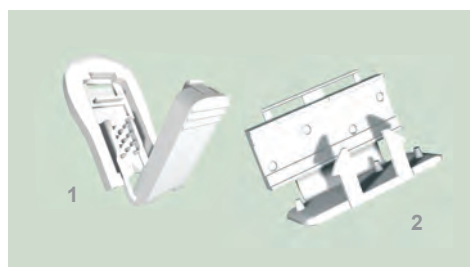

mod	CÓDIGO	Und./Caja	€/Und.
1	5002660	50	0,418
2	5002633	50	0,418

clip bloqueo cosido



CÓDIGO	Und./Caja	€/Und.
5002607	100	0,659

pletina fibra de vidrio

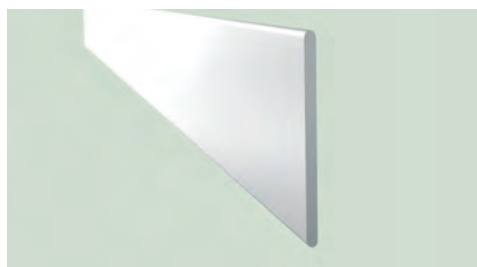

medida	CÓDIGO	Mts./Caja	€/Mts.
30x4	5007535	180	2,913

pletina aluminio blanco



medida	CÓDIGO	Mts./Caja	€/Mts.
25x3	5007534	180	4,200
40x3	5007536	180	7,352
30x4	5007533	180	7,423

pletina transparente



medida	CÓDIGO	Mts./Caja	€/Mts.
40x5	5007545	150	7,929

protector de pletina



medida	CÓDIGO	Und./Caja	€/Und.
25x3	5007541	1000	0,183
30x4	5007543	1000	0,246
40x3	5007542	1000	0,220

varilla de fibra de vidrio



medida	CÓDIGO	Mts./Caja	€/Mts.
3mm	5007744	600	0,389
4mm	5007745	600	0,405
trans 4mm	5007748	600	0,376

protector varilla



medida	CÓDIGO	Und./Caja	€/Und.
4mm	5007546	1000	0,101

estor cordón mini

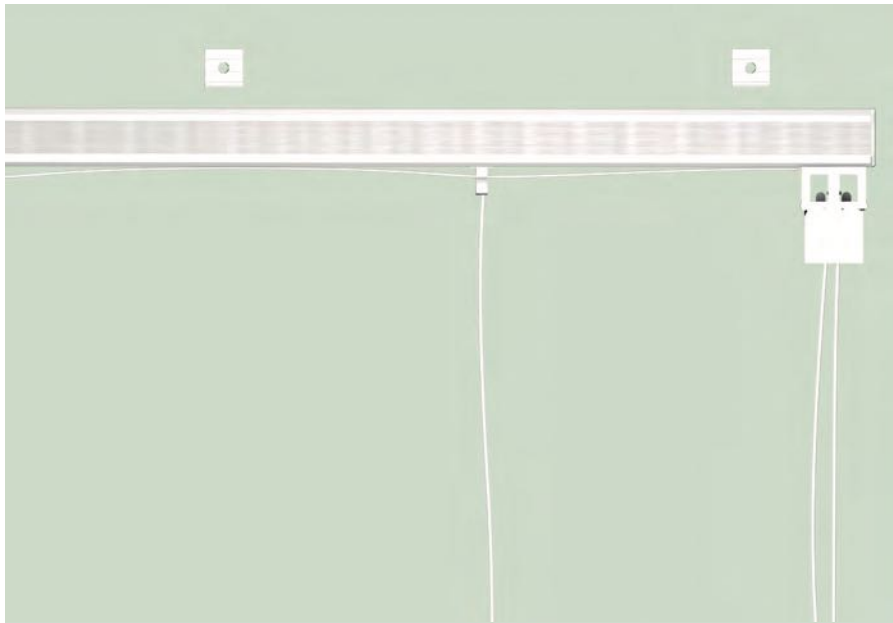

varillas

CÓDIGO	medida (cms.)	€/Und.
5017301	60	16,376
5017302	80	19,316
5017303	100	22,210

pachetto

CÓDIGO	medida (cms.)	€/Und.
5017401	60	15,317
5017402	80	17,258
5017403	100	19,152

estor cordón mini adhesivo



varillas

CÓDIGO	medida (cms.)	€/Und.
5017501	60	19,551
5017502	80	23,608
5017503	100	27,619

pachetto

CÓDIGO	medida (cms.)	€/Und.
5017601	60	18,493
5017602	80	21,550
5017603	100	24,562

perfil 2005 velcro



CÓDIGO	Mts./Caja	€/Mts.
5001551	288	5,216

perfil 2005 adhesivo

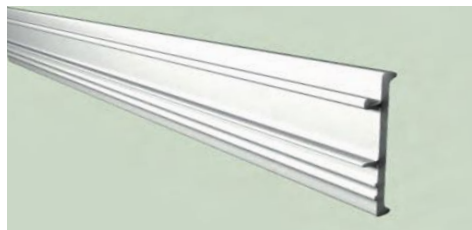

CÓDIGO	Mts./Caja	€/Mts.
5001557	180	2,656

freno stor mini



CÓDIGO	Und./Caja	€/Und.
6610017	20	2,216

guía caída stor mini



CÓDIGO	Und./Caja	€/Und.
6610018	500	0,428

soporte acercamiento



CÓDIGO	Und./Caja	€/Und.
5002603	500	0,208

terminal perfil (nylon)



CÓDIGO	Und./Caja	€/Und.
5002512	100	0,258

anilla final modelo pera (trans.)



CÓDIGO	Und./Caja	€/Und.
5002531	500	0,088

cordón 1'5



CÓDIGO	Mts./Bob	€/Mts.
5008740	500	0,090

soporte presión

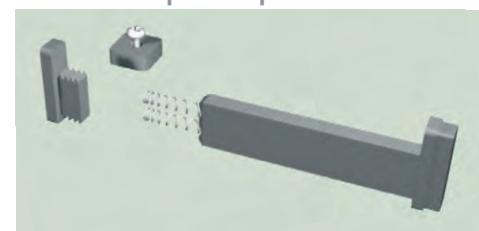

CÓDIGO	Und./Caja	€/Und.
5002602	25	5,886

protector pletina



medida	CÓDIGO	Und./Caja	€/Und.
25x3	5007541	1000	0,183
30x4	5007543	1000	0,246
40x3	5007542	1000	0,220

pletina aluminio blanco



medida	CÓDIGO	Mts./Caja	€/Mts.
25x3	5007534	180	4,200
40x3	5007536	180	7,352
30x4	5007533	180	7,423

pletina transparente



medida	CÓDIGO	Mts./Caja	€/Mts.
40x5	5007545	150	7,929

pomo campanilla plástico



CÓDIGO	Und./Caja	€/Und.
5002520	100	0,181

pomo madera mate



CÓDIGO	Und./Caja	€/Und.
5002558	50	0,796

pomo madera encerado



CÓDIGO	Und./Caja	€/Und.
5002727	50	1,269

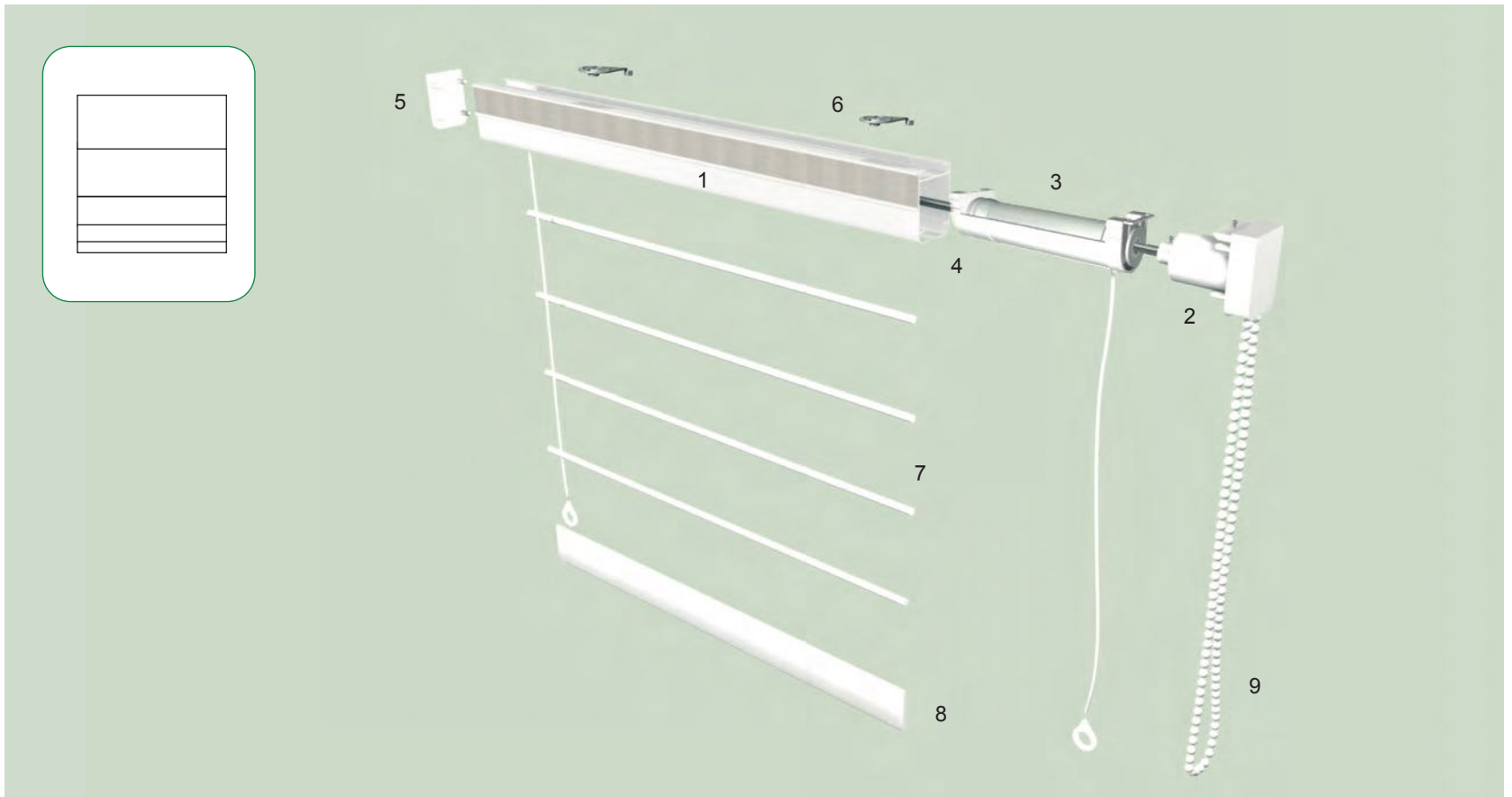

componentes

artículo	Und.	medida
1 - Perfil 2020 velcroado bco.	1	= estor
2 - Freno cadena 2020 montado	1	---
3 - Carrete 2020 montado (con hilo)	2, 3 o 4	2'60 x caída
4 - Barra móvil hexagonal	1	= estor
5 - Tapa final 2020	1	---
6 - Soporte 2020 techo	2, 3 o 4	---
7 - Varilla fibra 4 mm.	8	= estor
8 - Pletina aluminio 25x3	1	= estor
9 - Cadena accionamiento	1	3mts.

CÓDIGO	medida	caídas	Und./Caja	€/Und.
5016406	60	2	30	45,016
5016407	70	2	30	47,393
5016408	80	2	30	49,770
5016409	90	2	30	52,147
5016410	100	2	30	54,524
5016411	110	2	30	56,902
5016412	120	2	30	59,279
5016413	130	2	30	61,658
5016414	140	3	30	64,777
5016415	150	3	30	71,696
5016416	160	3	30	74,073
5016417	170	3	30	76,451
5016418	180	3	30	78,830
5016419	190	3	30	81,207
5016420	200	3	30	83,584
5016421	210	4	30	90,504
5016422	220	4	30	93,622
5016423	230	4	30	96,002
5016424	240	4	30	98,379
5016425	250	4	30	100,756

colores disponibles



blanco



beige



gris



inox



negro

Altura máxima de la caída de 3'10 mts / Las medidas especiales o demás variaciones sufrirán un incremento del 10% por manipulación.
Disponible en color beige, gris, negro e inox con un incremento del 20%.

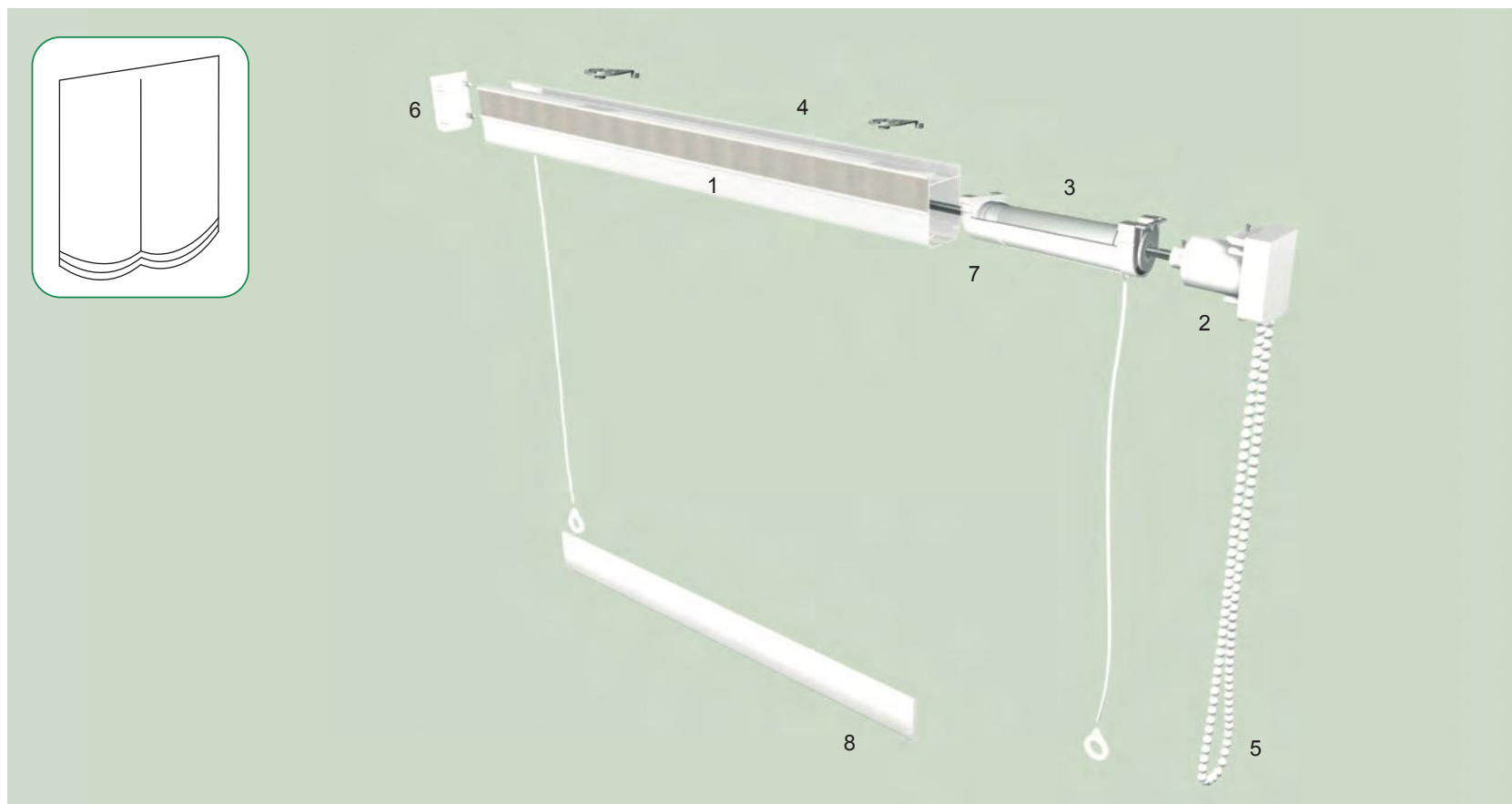

componentes

artículo	Und.	medida
1 - Perfil 2020 velcrado bco.	1	= stor
2 - Freno cadena 2020 montado	1	---
3 - Carrete 2020 montado (con hilo)	2, 3 o 4	2'60 x caída
4 - Soporte 2020 techo	2, 3 o 4	---
5 - Cadena accionamiento	---	3mts.
6 - Tapa final 2020	1	---
7 - Barra movil hexagonal	1	= estor
8 - Pletina aluminio 25x3	1	= estor
9. Romana Presillas transparente	1	= caída

colores disponibles



blanco



beige



gris



inox



negro

CÓDIGO	medida	caídas	Und./Caja	€/Und.
5016306	60	2	30	46,385
5016307	70	2	30	48,101
5016308	80	2	30	49,818
5016309	90	2	30	51,534
5016310	100	2	30	60,415
5016311	110	3	30	62,131
5016312	120	3	30	63,848
5016313	130	3	30	65,566
5016314	140	3	30	68,025
5016315	150	3	30	69,829
5016316	160	4	30	78,708
5016317	170	4	30	80,426
5016318	180	4	30	82,144
5016319	190	4	30	83,859
5016320	200	4	30	85,577
5016321	210	5	30	94,542
5016322	220	5	30	97,003
5016323	230	5	30	98,721
5016324	240	5	30	100,437
5016325	250	5	30	102,155

Altura máxima de la caída de 3'10 mts / Las medidas especiales o demás variaciones sufrirán un incremento del 10% por manipulación.
Disponible en color beige, gris, negro e inox con un incremento del 20%.

perfil 2020 velcrado blanco



CÓDIGO	Mts./Caja	€/Mts.
5001701	120	10,798

freno cadena 2020



caída	CÓDIGO	Und./Caj	€/Und.
1:1	5001702	25	9,673
1:4	5001707	25	9,673

freno cadena 2020 montado



caída	CÓDIGO	Und./Caj	€/Und.
1'50	5001712	25	16,006
1'75	5001713	25	16,655

carrete cordón 2020

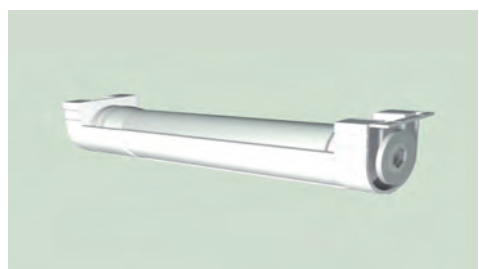

CÓDIGO	Und./Caja	€/Und.
5001708	25	3,738

carrete cordón 2020 montado

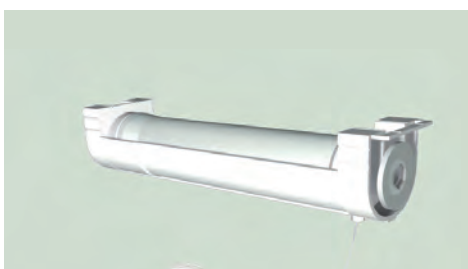

CÓDIGO	Und./Caja	€/Und.
5001703	25	4,454

barra movil hexagonal

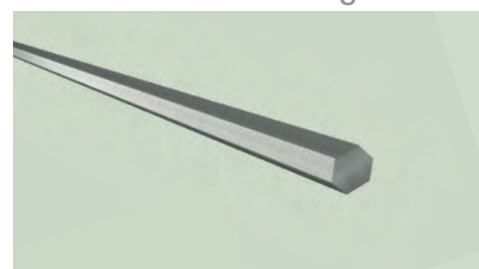

CÓDIGO	Mts./Caja	€/Mts.
5001504	180	2,216

soporte techo nylon



CÓDIGO	Und./Caja	€/Und.
5001706	100	0,741

soporte techo metal



CÓDIGO	Und./Caja	€/Und.
5001806	100	1,233

soporte universal



CÓDIGO	Und./Caja	€/Und.
5001705	100	1,537

tapa final 2020



CÓDIGO	Und./Caja	€/Und.
5001704	100	0.347

anilla final modelo pera (transp.)



CÓDIGO	Und./Caja	€/Und.
5002531	500	0,088

tope cadena



CÓDIGO	Und./Caja	€/Und.
5033250	200	0,389

varilla de fibra de vidrio



medida	CÓDIGO	Mts./Caja	€/Mts.
4mm	5007745	600	0,405

protector varilla



medida	CÓDIGO	Und./Caja	€/Und.
4mm	5007546	1000	0,101

protector de pletina



medida	CÓDIGO	Und./Caj	€/Und.
25x3	5007541	1000	0,183
30x4	5007543	1000	0,246
40x3	5007542	1000	0,220

pletina aluminio blanco



medida	CÓDIGO	Mts./Caja	€/Mts.
25x3	5007534	180	4,200
40x3	5007536	180	7,352
30x4	5007533	180	7,423

pletina transparente



medida	CÓDIGO	Mts./Caja	€/Mts.
40x5	5007545	150	7,929

pomo



CÓDIGO	Und./Caja	€/Und.
5033256	50	2,059

cadena accionamiento 4,5x6



medida	CÓDIGO	Mts./Bobina	€/Mts.
3mm	5002525	250	1,276

cadena continúa



color	CÓDIGO	Und./Caja	€/Und.
1'00	5002522	50	4,748
1'25	5002567	50	5,389
1'50	5002534	50	6,025
1'75	5002535	50	6,663
2'00	5002560	50	7,298
2'50	5002569	50	8,572

cadena metálica 4,5x6



CÓDIGO	Mts./Bobina	€/Mts.
M5002525	125	1,949

cadena continúa metálica



caída	CÓDIGO	Und./Caja	€/Und.
1'00	M5002560	50	5,109
1'25	M5002561	50	6,084
1'50	M5002562	50	7,058
1'75	M5002563	50	8,033
2'00	M5002564	50	9,007
2'50	M5002565	50	10,956

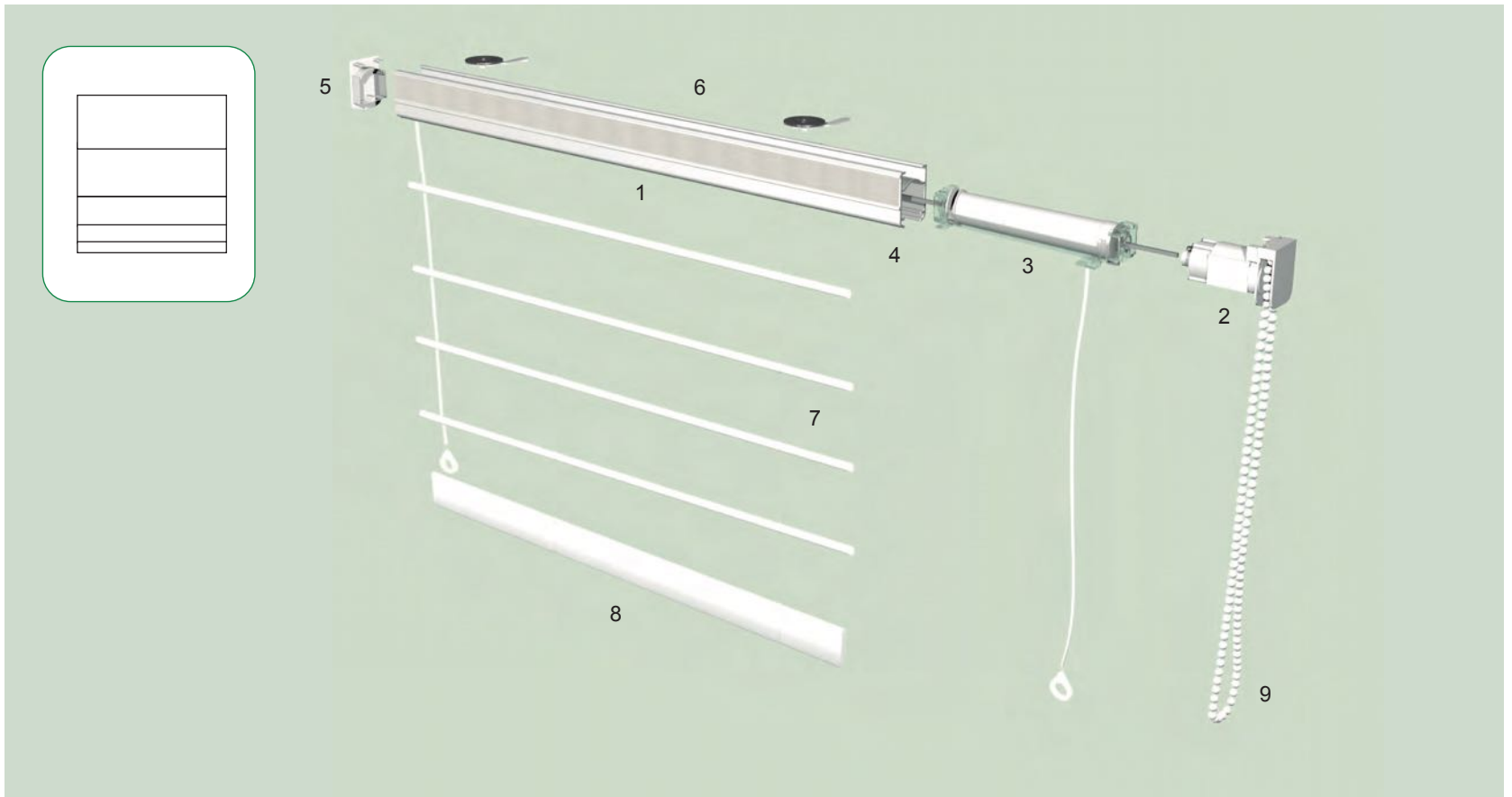

componentes

artículo	Und.	medida
1 - Perfil 2020 velcro bco.	1	= estor
2 - Freno cadena 2030 montado	1	---
3 - Carrete 2030 montado (con hilo)	2, 3 o 4	2'60 x caída
4 - Barra móvil hexagonal	1	= estor
5 - Tapa final 2030	1	---
6 - Soporte 2030 techo	2, 3 o 4	---
7 - Varilla fibra 4 mm.	8	= estor
8 - Pletina aluminio 25x3	1	= estor
9 - Cadena accionamiento	1	3mts.

CÓDIGO	medida	caídas	Und./Caja	€/Und.
5017106	60	2	25	47,267
5017107	70	2	25	49,764
5017108	80	2	25	52,259
5017109	90	2	25	54,755
5017110	100	2	25	57,250
5017111	110	2	25	59,747
5017112	120	2	25	62,244
5017113	130	2	25	64,741
5017114	140	3	25	68,017
5017115	150	3	25	75,281
5017116	160	3	25	77,778
5017117	170	3	25	80,275
5017118	180	3	25	82,772
5017119	190	3	25	85,268
5017120	200	3	25	87,763
5017121	210	4	25	95,029
5017122	220	4	25	98,305
5017123	230	4	25	100,802
5017124	240	4	25	103,299
5017125	250	4	25	105,794

Altura máxima de la caída de 3'10 mts / Las medidas especiales o demás variaciones sufrirán un incremento del 10% por manipulación.

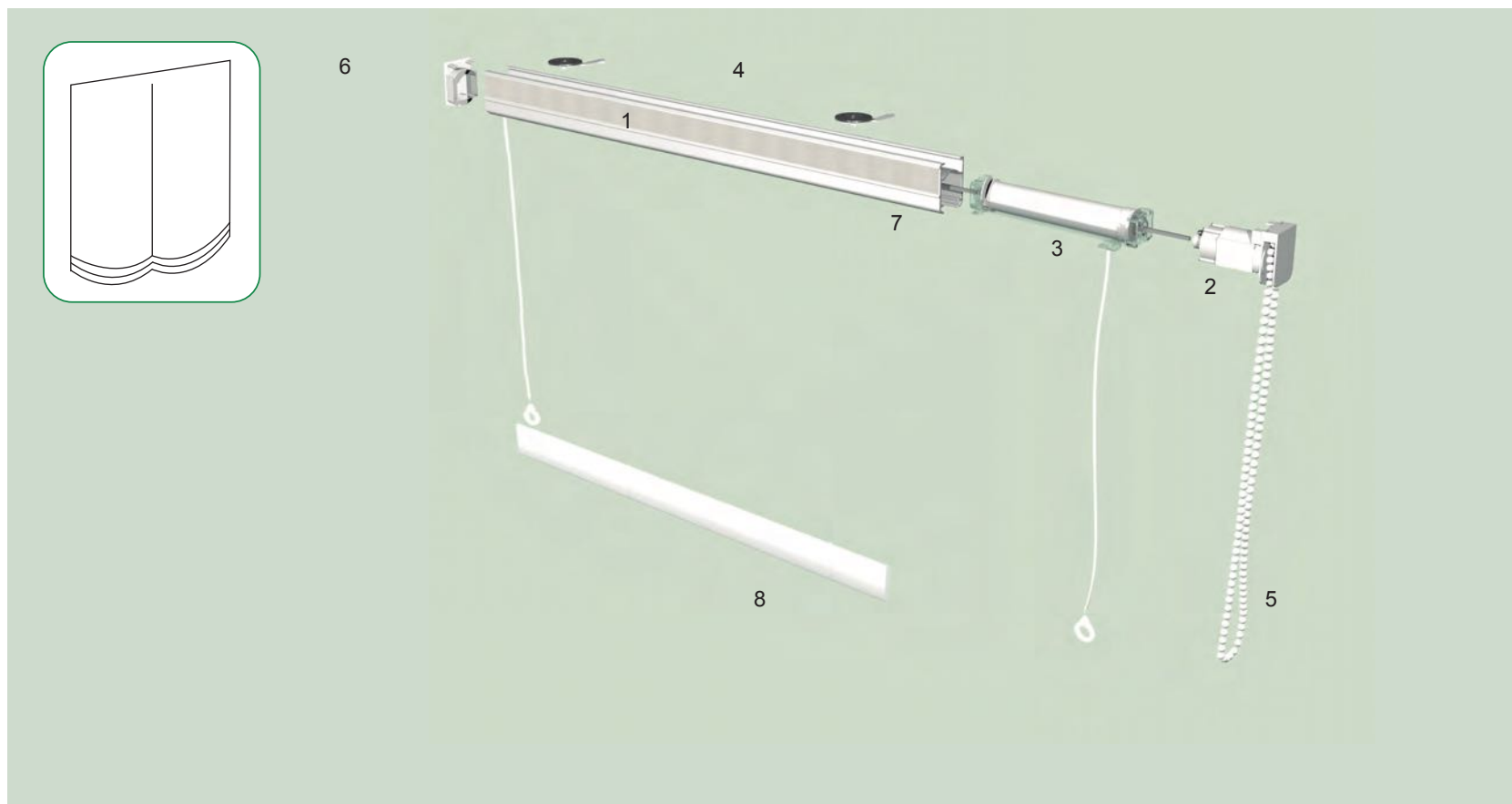

componentes

artículo	Und.	medida
1 - Perfil 2030 velcrado bco.	1	= estor
2 - Freno cadena 2030 montado	1	---
3 - Carrete 2030 montado (con hilo)	2, 3 o 4	2'60 x caída
4 - Varilla fibra 4 mm.	2, 3 o 4	---
5 - Tapa final 2030	---	3mts.
6 - Soporte 2030 techo	1	---
7 - Barra móvil hexagonal	1	= estor
8 - Pletina aluminio 25x3	1	= estor
9 - Romana Presillas transparente	1	= caída

CÓDIGO	medida	caídas	Und./Caja	€/Und.
5017206	60	2	25	48,705
5017207	70	2	25	50,507
5017208	80	2	25	52,309
5017209	90	2	25	54,111
5017210	100	2	25	63,437
5017211	110	3	25	65,239
5017212	120	3	25	67,040
5017213	130	3	25	68,844
5017214	140	3	25	71,427
5017215	150	3	25	73,327
5017216	160	4	25	82,643
5017217	170	4	25	84,447
5017218	180	4	25	86,251
5017219	190	4	25	88,053
5017220	200	4	25	89,857
5017221	210	5	25	99,269
5017222	220	5	25	101,854
5017223	230	5	25	103,658
5017224	240	5	25	105,460
5017225	250	5	25	107,264

Altura máxima de la caída de 3'10 mts / Las medidas especiales o demás variaciones sufrirán un incremento del 10% por manipulación.

perfil 2030 velcrado blanco



CÓDIGO	Mts./Caja	€/Mts.
5001901	58	11,355

freno cadena 2030



caída	CÓDIGO	Und./Caj	€/Und.
1:1	5001902	50	10,168
1:4	5001903	50	10,494

freno cadena 2030 montado



caída	CÓDIGO	Und./Caj	€/Und.
1:15	5001904	50	17,319
1:75	5001905	50	17,661

freno cadena 2030 seguridad infantil

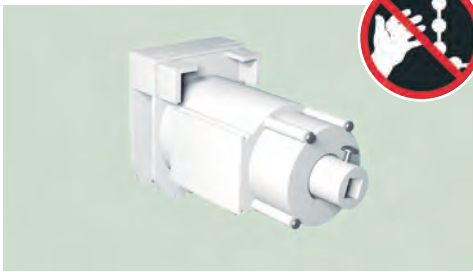

CÓDIGO	Und./Caja	€/Und.
5001900	50	15,900

carrete cordón 2030

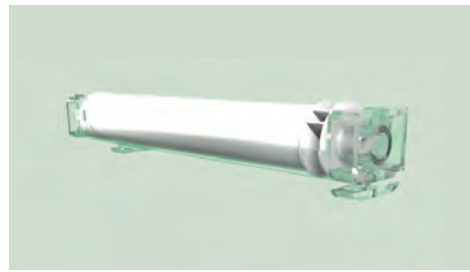

CÓDIGO	Und./Caja	€/Und.
5001911	50	4,234

carrete cordón 2030 montado



CÓDIGO	Und./Caja	€/Und.
5001912	50	4,916

barra movil cuadrada



CÓDIGO	Mts./Caja	€/Mts.
5002553	360	2,173

soporte techo 2030 metal



CÓDIGO	Und./Caja	€/Und.
5001914	250	0,773

soporte universal clip 2030



CÓDIGO	Und./Caja	€/Und.
5001915	100	1,273

soporte universal leva 2030

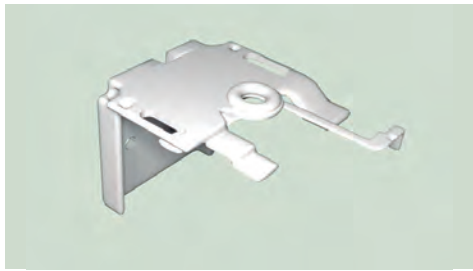

CÓDIGO	Und./Caja	€/Und.
5001916	100	1,067

tapa final 2030



CÓDIGO	Und./Caja	€/Und.
5001918	50	0,729

anilla final modelo pera (transp.)



CÓDIGO	Und./Caja	€/Und.
5002531	500	0,088

tope cadena



CÓDIGO	Und./Caja	€/Und.
5033250	200	0,389

varilla de fibra de vidrio

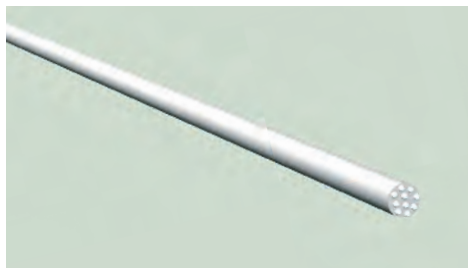

medida	CÓDIGO	Mts/Caja	€/Mts.
4mm	5007745	600	0,405

protector varilla



medida	CÓDIGO	Und./Caja	€/Und.
4mm	5007546	1000	0,101

protector de pletina



medida	CÓDIGO	Und./Caja	€/Und.
25x3	5007541	1000	0,183
40x3	5007542	1000	0,220
30x4	5007543	1000	0,246

pletina aluminio blanco



medida	CÓDIGO	Mts/Caja	€/Mts.
25x3	5007534	180	4,200
40x3	5007536	180	7,352
30x4	5007533	180	7,423

pomo



CÓDIGO	Und./Caja	€/Und.
5033256	50	2,059

cadena continua



medida	CÓDIGO	Und./Caja	€/Und.
1'00	5002522	50	4,748
1'25	5002567	50	5,389
1'50	5002534	50	6,025
1'75	5002535	50	6,663
2'00	5002560	50	7,298
2'50	5002569	50	8,572

cadena continua metálica



color	CÓDIGO	Und./Caja	€/Und.
1'00	M5002560	50	5,109
1'25	M5002561	50	6,084
1'50	M5002562	50	7,058
1'75	M5002563	50	8,033
2'00	M5002564	50	9,007
2'50	M5002565	50	10,956

cadena accionamiento 4,5x6

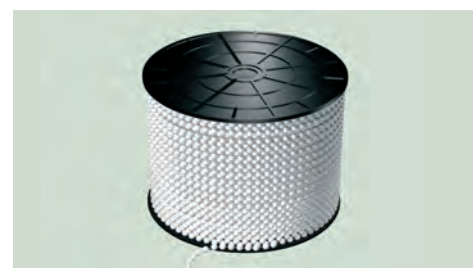

medida	CÓDIGO	Mts./Bobina	€/Mts.
3mm	5002525	250	1,276

cadena metálica 4'5x6

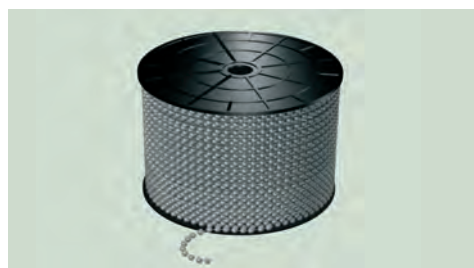

CÓDIGO	Mts./Bobina	€/Mts.
M5002525	125	1,948

empalme cadena continuo



CÓDIGO	Und./Caja	€/Und.
5002559	50	1,189

rótula angular



CÓDIGO	Und./Caja	€/Und.
5001930	10	31,500

características técnicas

Par nominal	0'8 Nm
Velocidad nominal	45 rpm
Alimentación	12 Vdc
Potencia nominal	10 W
Corriente nominal	0'83 A
Nº mx rotaciones	∞
Frecuencia	433'92
Ruido en funcionamiento	45 dB
Máx. carga	5 Kg
Ancho mínimo	0'5 m
Ancho máximo	3
Alto máximo	3,5
Área máxima	6 m ²
Grado de protección	40 IP
Medida	193
Garantía	2 años



CÓDIGO	Nm	€/Und.
5001932	10	295

transformador / inversor 230-24V

CÓDIGO	Und./Caja	€/Und.
5001933	5	77,580



pulsador inalámbrico

canales	CÓDIGO	€/Und.
1	5001924	114



mando a distancia



enox		
CÓDIGO	canales	€/Und.
5033604	1	114
5033605	6	128
5033606	16	136

eos		
CÓDIGO	canales	€/Und.
5030001	1	104
5030002	6	116
5030005	16	130



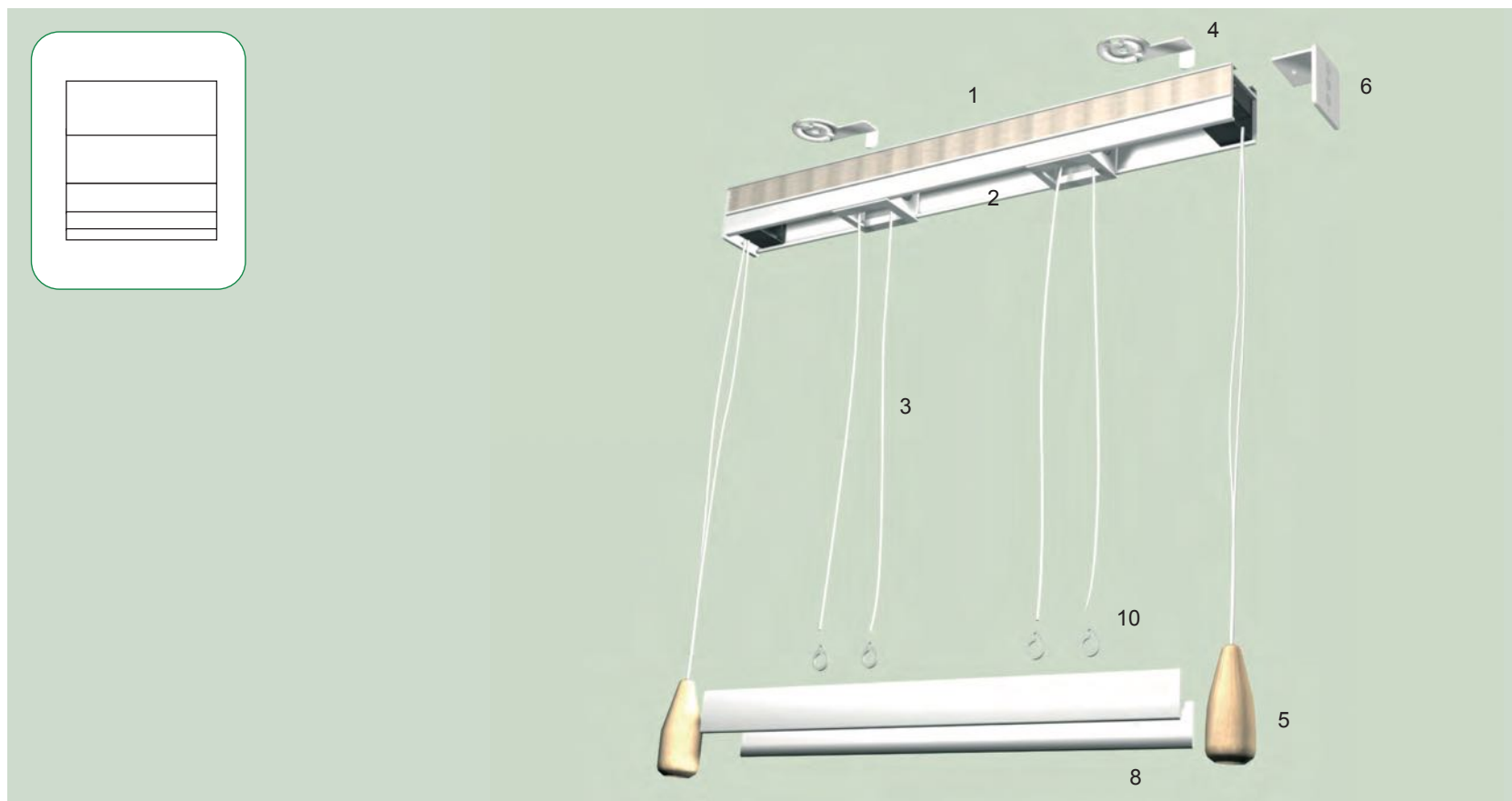

componentes

artículo	Und.	medida
1 - Perfil 2015	1	= estor
2 - Guía cordón 2015	2, 3 o 4	2'60 x caída
3 - Cordón stor	1	---
4 - Soporte 2015 techo	2, 3 o 4	---
5 - Pomo de madera	2	---
6 - Tapa final 2015	2	---
7 - Cinta stor vh (bco)	---	= varilla
8 - Pletina aluminio 25X3mm.	2	= estor
9 - Trivel 20mm liso	---	= estor
10 - Anilla final (modelo pera)	2, 3 o 4	---
11 - Varilla fibra 4 mm.	8	= estor
12 - Romana presillas transp	1	= caídas

CÓDIGO	medida	caídas	Und./Caja	€/Und.
5016206	60	2	8	40,725
5016207	70	2	8	43,970
5016208	80	2	8	47,214
5016209	90	2	8	50,461
5016210	100	2	8	53,710
5016211	110	3	8	56,946
5016212	120	3	8	60,197
5016213	130	3	8	63,443
5016214	140	3	8	67,778
5016215	150	3	8	74,130
5016216	160	4	8	77,385
5016217	170	4	8	80,636
5016218	180	4	8	87,039
5016219	190	4	8	90,304
5016220	200	4	8	93,566
5016221	210	5	8	96,825
5016222	220	5	8	101,170
5016223	230	5	8	104,429
5016224	240	5	8	107,688
5016225	250	5	8	110,960

Altura máxima de la caída de 3'10 mts / Las medidas especiales o demás variaciones sufrirán un incremento del 10% por manipulación.